

Key Features&Benefits



- **Low Power Consumption**
- **High Precision**
- **High Sensitivity**
- **Wide Linear Range**
- **Excellent Repeatability and Stability**

Applications

Industrial Safety、 Mining、 Residential Safety、 Emissions、 Environmental Monitoring

Technical Specifications

MEASUREMENT

Operating Principle		3-electrodes electrochemical
Detection Range		0 to 1000ppm
Maximum Overload		2000ppm
Sensitivity		0.045 ± 0.01 (uA/ppm)
Baseline Offset(20℃)		-20 to +3ppm equivalent
Baseline Drift(-20~40℃)		<30ppm equivalent
Response Time (T90)		≤90 seconds
Repeatability		2% of signal
Linearity		Linear
Long Term Output Drift		<2% signal/month

ELECTRICAL

Recommended Load Resistor		10Ω
Bias Potential		not required

ENVIRONMENTAL

Temperature Range		-20℃ to 50℃
Operating Humidity		15 to 90%RH non-condensing
Pressure Range		90 to 110kPa
Storage Temperature		0℃ to 20℃

LIFETIME

Storage Life		6 months in sealed container
Expected Operating Life		3 years in air
Warranty		18 months from date of despatch

PHYSICAL CHARACTERISTICS

Weight		11g(approx)
Orientation Sensitivity		None

Product Dimensions

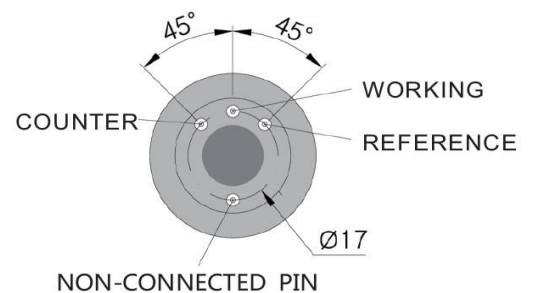
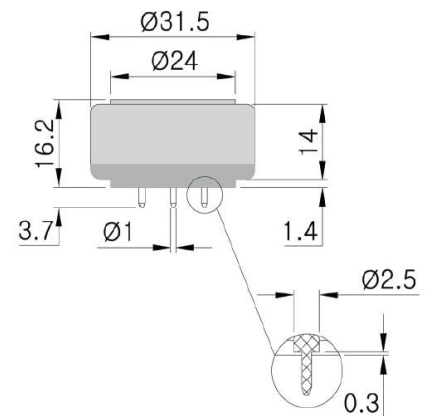

Note1: All performance specifications are based upon the following environment conditions: 20℃, 50% relative humidity and 1 atm (1013 mBar or ambient pressure).

Note2: PCB sockets are recommended for the sensor pin connection. Soldering to the sensor should be avoided.

Cross-sensitivity Data (20°C)

- Notes:**1. Calibration with cross sensitivity gas is not recommended.
2. The cross sensitivity may fluctuate between +/- 30% and may differ from batch to batch or from sensor's life time.
3. The cross sensitivities are including but not limited to the above gases. It may also respond to other gases.

Gas	Concentration used (ppm)	DH7-H ₂ -1000 (ppm H ₂)
CO	500	325
C ₂ H ₄	100	15
H ₂ S	50	0
SO ₂	50	1.5
NO ₂	50	0

Precautions

1. The sensor should be prevented from organic solvents and corrosive gases.
2. The sensor should not be stored in dusty, dirty areas and anaerobic environment.
3. The sensor must not be exposed to very high concentrations of the analyte permanently.
4. Excessive shock or vibration should be prevented to avoid internal damages.
5. The pins should not be broken and bent.
6. Electrolyte leakage can cause damage, please do not disassemble the sensor.
7. The working and reference electrodes should be in short-circuit condition in storage.

➔ CONTACT US

Asensor Technologies Co., Ltd
Address: South Building, No.29 High-tech South
1st Road, South Area, High-tech Industrial Park,
Shenzhen, Guangdong
Email: szasensor@163.com
Tel: +86-755-26520508
Fax: +86-755-26520539
Web site : www.szasensor.com